

Model-based fault detection and isolation in steer-by-wire vehicle using sliding mode observer[†]

Jae Sung IM¹, Fuminori OZAKI², Tae Kyeong YEU³ and Shigeyasu KAWAJI^{1,*}

¹Graduate School of Science and Technology, Kumamoto University, Kumamoto 860-8555, Japan

²OMRON Corporation, Kiya-cho, Kyoto 619-0283, Japan

³Korean Ocean Research & Development, Daejeon 305-343, Korea

(Manuscript Received October 30, 2007; Revised March 1, 2009; Accepted March 9, 2009)

Abstract

Steer-by-Wire system (SbW), in which the conventional mechanical linkages between the steering wheel and the front wheel are removed, is suited to active steering control, improving vehicle stability, dynamics and maneuverability. And SbW is implemented to autonomous steering control to assist the driver. However, the SbW vehicle contains unsolved important problems about fault tolerant function. For example, it is the detection of sensor fault and multiplicative fault simultaneously. Fault detection and isolation (FDI) is essential in fault-tolerant problems, and conventional FDI for SbW was based on Kalman filter. But this method has weak robustness and cannot detect sensor fault and multiplicative fault simultaneously. We propose a novel model-based fault detection and isolation method using sliding mode observer in the SbW vehicle, which contains measurement of sensor fault and multiplicative fault. The effectiveness of the proposed method is verified by simulations.

Keywords: Fault detection; Sliding mode observer; Steer by wire; Multiplicative fault

1. Introduction

A steer-by-wire (SbW) system is one in which the conventional mechanical linkages between the steering wheel and the front wheel are removed, and is operated by electronic actuators. The SbW system has many advantages compared to a conventional steering system because of easy elimination of interference between the driver and the steering system. For examples, the SbW system can increase the freedom to tune the steering feel and also can improve steering maneuverability, using a steering control device such as a joystick. Thus, the SbW system is suited to active steering control, improving vehicle stability, dynamics and maneuverability. And SbW is implemented to

autonomous steering control to assist the driver [1-3]. However, since there would be no mechanical redundancy, the reliability of the system needs to be improved by using fault tolerant function.

Fault detection and isolation (FDI) is essential in fault tolerant problems and is expected to be very important for general X-by-Wire technique. A fault is deemed to occur when the system suffers an abnormal condition, such as a component malfunction. To ensure that the process operation satisfies the performance specifications, the faults in the process need to be detected, diagnosed, and removed. The purpose of fault detection is to determine that a fault has occurred in the system, whereas fault isolation is used to diagnose the location of the detected fault. The fault, if it is undetected, could have catastrophic consequences and could incur financial losses. The most obvious method for automatic fault detection is the use of hardware redundancy, where measurements

[†] This paper was recommended for publication in revised form by Associate Editor Kyoungsu Yi

* Corresponding author. Tel.: +81 96 342 3631, Fax.: +81 96 342 3631

E-mail address: kawaji@cs.kumamoto-u.ac.jp

© KSME & Springer 2009

from multiple sensors are compared with each other and the existence of failure is determined by implementing the voting mechanism. In many practical situations, however, hardware redundancy may not be possible or desirable, since it imposes a penalty in terms of volume, weight and costs etc. In other situations where a fault exists in the actuator, its direct measurement is often not possible [4].

In the FDI technique, functional redundancy plays a key roll, which is obtained by comparing the measured output and the model output of the faulty system. Several schemes for the prompt detection of incipient instrument faults in dynamic systems have been proposed [5]. These schemes require the use of state estimators in the monitoring system to generate redundant signals. So, the faulty system must be modeled appropriately for successful diagnosis and isolation. One approach is to model faults as additive perturbations to an input/output model of the normal system [6]. Such a representation is appropriate to model subtle drifts in measuring devices, abrupt sudden failures of sensors, or an actuating device becoming stuck or failing to respond to a reference command signal. Many researches in the area of FDI have been directed towards this additive fault scenario. However, in other situations such as the failure of system component, the results are ‘internal’ and may be better described by means of multiplicative or parametric faults. In this multiplicative scenario, the fault signals appear multiplied by the states and/or inputs [7]. The multiplicative fault scenario is much less well studied than the additive approach. Alcort-Garcia et al. (1999) studied multiplicative fault isolation in linear systems, and Hofling et al. (1995) did parameter estimation triggered by continuous-time parity equations [8, 9].

Conventional FDI systems for SbW were based on the Kalman filter and parity space method [10, 11]. However, these methods concentrated detection of the faults as additive perturbations to an input/output model. These schemes are weak for multiplicative faults that are variations in system parameters, such as variation of the tire cornering stiffness. Besides, the methods are inaccurate to occurrence of sensor fault and multiplicative fault simultaneously. Moreover, the methods have weak robustness for some noise and complex fault signal.

A sliding mode observer yielding insensitivity to unknown parameter variations and noise was proposed by [12]. The fundamental difference between

sliding mode observer and other observers is that the sliding mode observer has usually discontinuous input terms so that the error trajectories move onto a specified attractive hyperplane. Robustness, insensitivity properties, simplicity of design and straightforward implementation are motivations to consider sliding observers as a powerful.

In this paper, we consider simple linear models of the front steering system and vehicle dynamics for the SbW vehicle with multiplicative fault or sensor fault. And, we propose the design of the simultaneous sensor and multiplicative faults detection for SbW vehicles using a sliding mode observer. The effectiveness of the proposed method is verified by simulations.

2. Problem statement

2.1 Model of SbW system

An SbW system is divided into two parts, steering wheel and front wheel, and contains two electronic actuators assisting in their operations. These two electronic actuators receive input signals from electronic control unit (ECU), and one actuator generates reactive torque to the steering wheel and the other actuator steers the front wheel by following the driver’s will. Fig. 1 shows the structure of SbW system which is reconstructed into SbW system using Toyota’s electronic vehicle (COMS).

The torque from the front wheel actuator is transmitted to the front tires through the front wheel system consisting of front wheel steering motor, ball screw gear, and tie rod. The front wheel angle is measured by encoder. The obtained data are transmitted to the ECU, in which the desired steering wheel angle and front wheel angle are calculated. Fig. 2

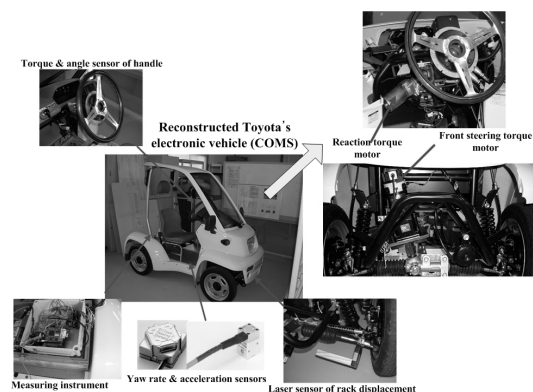

Fig. 1. Structure of SbW system.

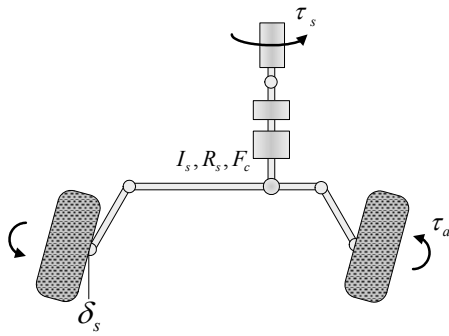

Fig. 2. Front wheel dynamics.

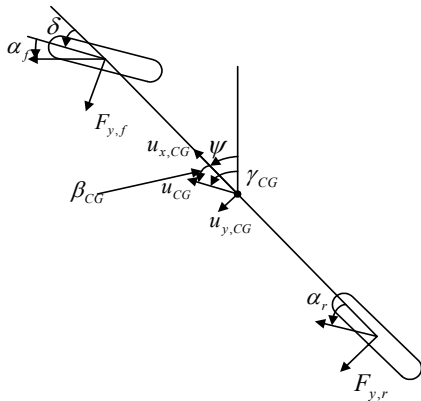

Fig. 3. Bicycle model.

shows the model of the front wheel, in which only the tie rod stiffness is considered and other stiffness is ignored because the stiffness of the tie rod has the greatest effect on steering angle.

The dynamics of the front wheel is described by

$$I_s \ddot{\delta}_s + R_s \dot{\delta}_s + \tau_f = r_s \tau_s - \tau_a \tag{1}$$

where δ_s is the front steering angle, τ_s and τ_a are the front wheel actuator torque and the aligning torque, respectively. I_s and R_s are the moment of inertia and damping of the front wheel system. r_s is the steering ratio of the steering system. And the coulomb friction τ_f due to friction is treated as an input:

$$\tau_f = F_c \text{sgn}(\dot{\delta}_s) \tag{2}$$

where the coulomb friction constant F_c is identified along with the inertia and damping constants using the ARX model. The aligning torque is a function of the vehicle state and represents significant disturbance to the steer-by-wire system.

A vehicle's dynamics in the horizontal plane can be represented by a bicycle model with states of sideslip angle β at the center of gravity (CG) and yaw rate γ as shown in Fig. 3 [13]. Assuming constant longitudinal velocity $u_x (= V)$, the state equation for the bicycle model can be written as

$$\dot{x}_v = A_v x_v + B_v \delta_s \tag{3}$$

where

$$x_v = [\beta \ \gamma]^T$$

$$A_v = \begin{bmatrix} -\frac{C_0}{mV} & -1 + \frac{C_1}{mV^2} \\ \frac{C_1}{I_z} & -\frac{C_2}{I_z V} \end{bmatrix}, \quad B_v = \begin{bmatrix} \frac{C_{\alpha f}}{mV} \\ \frac{C_{\alpha f} a}{I_z} \end{bmatrix},$$

$$C_0 = C_{\alpha f} + C_{\alpha r}, \quad C_1 = C_{\alpha r} b - C_{\alpha f} a,$$

$$C_2 = C_{\alpha f} a^2 + C_{\alpha r} b^2$$

where I_z is the polar moment of inertia of the vehicle, and m is the mass of the vehicle. $C_{\alpha f}$ and $C_{\alpha r}$ are the front and rear cornering stiffnesses, a and b are distances from the center of gravity to the front and rear axles, respectively. Note that the model is valid for tires operating in the linear region and small slip angles.

The aligning torque τ_a in Eq. (1) is related to the vehicle state as

$$\tau_a = -C_{\alpha f} (t_p + t_m) (\beta + \frac{a}{V} \gamma - \delta_s) \tag{4}$$

where t_p and t_m are the pneumatic and mechanical trails of the tire, respectively. In the following, in order to arrive at a linear model, t_p and t_m are assumed constant and known, as are $C_{\alpha f}$ and $C_{\alpha r}$ [14].

2.2 Problem statement

Most vehicle models assume fairly complex tire force models with various parameters, such as cornering stiffness used to characterize the interaction between the tire and the road. However, it is often difficult to determine these parameters precisely, since they are subject to great variability with changes in tire inflation pressure, road surface, weather condition etc [15, 16]. The uncertainty of front cornering stiffness coefficient is the source of the critical driving situation. Moreover, it has influence on the design of VSC systems such as active steering control system.

So, if the uncertainty of front cornering stiffness coefficient has occurred, then it is considered as cornering stiffness fault. And the damping coefficient of the front wheel system Eq. (1) is potentially fault-prone. Suppose $R_s = R_o + \Delta R_s$ in Eq. (1) where R_o is a nominal known parameter, and ΔR_s is uncertainty which represents the front wheel fault. We will estimate the above-mentioned uncertainties by FDI method using sliding mode observer.

Now, let's consider the following uncertain dynamic model that is to combine the vehicle model Eq. (3) with front steering model Eq. (1)

$$\begin{aligned} \dot{\mathbf{x}} &= (\mathbf{A} + \Delta_A)\mathbf{x} + \mathbf{B}_1\tau_s + \mathbf{B}_2\tau_f \\ \mathbf{y} &= \mathbf{C}\mathbf{x} + \mathbf{M}_s\mathbf{f}_s \end{aligned} \tag{5}$$

with

$$\begin{aligned} \mathbf{x} &= [\beta \quad \gamma \quad \delta_s \quad \dot{\delta}_s]^T, \\ \mathbf{A} &= \begin{bmatrix} -\frac{C_0}{mV} & -1 + \frac{C_1}{mV^2} & \frac{C_{af}}{mV} & 0 \\ \frac{C_1}{I_z} & -\frac{C_2}{I_zV} & \frac{aC_{af}}{I_z} & 0 \\ 0 & 0 & 0 & 1 \\ \frac{C_3}{I_s} & \frac{aC_3}{I_sV} & -\frac{C_3}{I_s} & -\frac{R_s}{I_s} \end{bmatrix}, \\ \Delta_A &= \begin{bmatrix} -\frac{\Delta C_{af}}{mV} & \frac{\Delta C_{af}}{mV^2} & \frac{\Delta C_{af}}{mV} & 0 \\ \frac{\Delta C_{af}}{I_z} & -\frac{\Delta C_{af}}{I_zV} & \frac{a\Delta C_{af}}{I_z} & 0 \\ 0 & 0 & 0 & 1 \\ \frac{\Delta C_{af}}{I_s} & \frac{a\Delta C_{af}}{I_sV} & -\frac{\Delta C_{af}}{I_s} & -\frac{\Delta R_s}{I_s} \end{bmatrix}, \\ \therefore C_3 &= (t_p + t_m)C_{af} \\ \mathbf{B}_1 &= \begin{bmatrix} 0 \\ 0 \\ 0 \\ \frac{r_s}{I_s} \end{bmatrix}, \mathbf{B}_2 = \begin{bmatrix} 0 \\ 0 \\ 0 \\ -\frac{1}{I_s} \end{bmatrix}, \\ \mathbf{C} &= \begin{bmatrix} 1 & 0 & 0 & 0 \\ 0 & 1 & 0 & 0 \\ 0 & 0 & 1 & 0 \\ 0 & 0 & 0 & 1 \end{bmatrix}, \mathbf{M}_s = \begin{bmatrix} 0 & 0 \\ \frac{a}{I_z} & 0 \\ 0 & 1 \\ 0 & 0 \end{bmatrix} \end{aligned}$$

where Δ_A represents an unknown multiplicative

Table 1. Catalog of the faults for SbW system.

Fault	Error In
Yaw rate sensor	γ
Steering angle sensor	δ_s
Front cornering stiffness coefficient	C_{af}
Steering motor	b_w

fault matrix. There are the cornering stiffness fault ΔC_{af} and front wheel fault ΔR_s . And \mathbf{f}_s represents unknown measurement faults. Table 1 lists a catalog of faults that can occur in the SbW system along with the variable.

The faults can be estimated by FDI method. And the reconstructed multiplicative fault signals especially can be used for designing a fault tolerant system such as active steering systems for control of vehicle stability. In the uncertain dynamic model Eq. (5), we assume that the side slip angle is estimated by sideslip estimation method using a combination of global positioning system (GPS) and inertial navigation system (INS) sensors in the output signal.

The uncertain dynamic model Eq. (5) can be re-expressed as in [17] which calls a faulty system

$$\begin{aligned} \dot{\mathbf{x}} &= \mathbf{A}\mathbf{x} + \mathbf{B}_1\tau_s + \mathbf{B}_2\tau_f + \mathbf{M}_m\Delta(t, x, u) \\ \mathbf{y} &= \mathbf{C}\mathbf{x} - \mathbf{M}_s\mathbf{f}_s \end{aligned} \tag{6}$$

where \mathbf{M}_m and $\Delta(t, x, u)$ is represented as

$$\begin{aligned} \mathbf{M}_m &= \begin{bmatrix} \frac{1}{mV} & 0 \\ \frac{a}{I_z} & 0 \\ 0 & 0 \\ -\frac{(t_p + t_m)}{I_s} & -\frac{1}{I_s} \end{bmatrix}, \\ \Delta(t, x, \tau_s) &= \begin{bmatrix} \Delta C_{af} Q_1(A, B, x) \\ \Delta R_s Q_2(A, B, x) \end{bmatrix} \\ \therefore Q_1(A, B, x) &= -\beta - \frac{a}{V}\gamma + \delta_s, \quad Q_2(A, B, x) = \dot{\delta}_s. \end{aligned}$$

The problem is to develop simultaneous measurement and multiplicative fault detection and isolation for the faulty system Eq. (6). For this, we will introduce a sliding mode observer in the next section.

3. FDI using sliding mode observer

In most previous works, FDI problems for the SbW

system just have been introduced through a residual signal. In practice, it is also important for rejecting the influence of faults to know the shape of faults. However, it is very difficult to obtain such information from the residual signal.

In this section the fault reconstruction method is developed by introducing the sliding mode observer with feedforward compensation signal and injection map.

3.1 Sliding mode observer

Consider the faulty system Eq. (6); the general form of the sliding mode observer can be given by

$$\begin{aligned} \dot{\mathbf{z}} &= \mathbf{Nz} + \mathbf{Ly} + \mathbf{J}_1\tau_s + \mathbf{J}_2\tau_f + \lambda\mathbf{v}(t) \\ \hat{\mathbf{y}} &= \mathbf{Cz} \end{aligned} \quad (7)$$

with $\mathbf{N} = \mathbf{A} - \mathbf{LC}$, $\mathbf{J}_1 = \mathbf{B}_1$ and $\mathbf{J}_2 = \mathbf{B}_2$, the matrix \mathbf{L} is chosen to stabilize the matrix \mathbf{N} . \mathbf{v} is an external feedforward compensation signal, and λ is the feedforward injection map. Without loss of the generality we can assume that $\mathbf{C}\lambda > 0$. Further, we assume that (\mathbf{N}, λ) is completely controllable [6]. Now, by choosing properly the feedforward injection map and external compensation signal, we prove the stability of the error dynamics and the existence of the sliding mode.

Let the state error \mathbf{e} and output error \mathbf{e}_y be $\mathbf{e} = \mathbf{x} - \mathbf{z}$ and $\mathbf{e}_y = \mathbf{Cx} - \mathbf{Cz}$. Subtracting Eq. (7) from Eq. (6), we get the state error dynamics by

$$\dot{\mathbf{e}}(t) = \mathbf{Ne}(t) + \mathbf{M}^*\mathbf{f}^* - \lambda\mathbf{v} \quad (8)$$

and the dynamics of output error \mathbf{e}_y by

$$\dot{\mathbf{e}}_y(t) = \mathbf{CNe}(t) + \mathbf{CM}^*\mathbf{f}^* - \mathbf{C}\lambda\mathbf{v} \quad (9)$$

where λ can be interpreted as the control input distribution map for the system Eq. (9). And the faults signal matrixes are represented as

$$\mathbf{f}^* = \begin{bmatrix} \Delta \\ \mathbf{f}_s \end{bmatrix}, \quad \mathbf{M}^* = [\mathbf{M}_m \quad \mathbf{LM}_s] \quad (10)$$

Since the observer gain matrix \mathbf{L} is selected to satisfy the stability of error dynamics. Next, for the existence of the sliding mode and for reaching and crossing of the sliding surface, the external feedforward compensation signal is set as

$$\mathbf{v}(t) = \mathbf{W} \operatorname{sgn}(\mathbf{e}_y) = \mathbf{W} \frac{\mathbf{e}_y}{\|\mathbf{e}_y\|}, \quad \mathbf{e}_y \neq 0 \quad (11)$$

where \mathbf{W} is diagonal matrix with elements w_k as

$$w_k \geq \frac{|\mathbf{C}_k \mathbf{M}^* \mathbf{f}^*|}{\mathbf{C}_k \lambda_k} m, \quad k=1, \dots, p \quad (12)$$

and the vectors \mathbf{C}_k and λ_k are the k -th column and row of matrices \mathbf{C} and λ respectively. m is boundary of fault and w_k must satisfy $\mathbf{C}_k \mathbf{M}^* \mathbf{f}^* \neq 0$. Now we establish the condition so that $\lim_{t \rightarrow \infty} \mathbf{e}(t) = 0$. Let \mathbf{P} be the solution of the following Lyapunov equation:

$$\mathbf{NP} + \mathbf{PN}^T = -\mathbf{Q} \quad (13)$$

where \mathbf{Q} is an arbitrary positive definite symmetric matrix. For leading to the stability of the output error dynamics Eq. (9) and the existence of sliding mode, the feedforward injection map λ is chosen as

$$\lambda = \mathbf{P}^{-1} \mathbf{C}^T \quad (14)$$

under the assumption that

$$\mathbf{M}^* \mathbf{f}^* = \lambda \boldsymbol{\rho} \quad (15)$$

where $\boldsymbol{\rho}$ is constant matrix. The stability of the state error dynamics Eq. (8) is guaranteed by this selection of Eq. (14) and the suitable condition Eq. (15). Let a Lyapunov function candidate for Eq. (8) as

$$\mathbf{V}(\mathbf{e}(t)) = \mathbf{e}^T(t) \mathbf{P} \mathbf{e}(t) \quad (16)$$

Then the time derivative $\dot{\mathbf{V}}$ satisfies

$$\begin{aligned} \dot{\mathbf{V}}(\mathbf{e}(t)) &= \mathbf{e}^T(t) (\mathbf{NP} + \mathbf{PN})^T \mathbf{e}(t) + 2\mathbf{e}^T(t) \mathbf{PM}^* \mathbf{f}^* - 2\mathbf{e}^T(t) \mathbf{P}\lambda\mathbf{v}(t) \\ &\leq -\mathbf{e}^T(t) \mathbf{Q} \mathbf{e}(t) + 2 \|\mathbf{e}^T(t) \mathbf{PM}^* \mathbf{f}^*\| m - 2\mathbf{e}^T(t) \mathbf{P}\lambda\mathbf{W} \frac{\mathbf{C}\mathbf{e}(t)}{\|\mathbf{C}\mathbf{e}(t)\|} \\ &= -\mathbf{e}^T(t) \mathbf{Q} \mathbf{e}(t) + 2 \|\mathbf{e}^T(t) \mathbf{PM}^* \mathbf{f}^*\| m - 2\mathbf{e}^T(t) \mathbf{P}\lambda\mathbf{W} \frac{\lambda^T \mathbf{P} \mathbf{e}(t)}{\|\lambda^T \mathbf{P} \mathbf{e}(t)\|} \\ &\leq -\mathbf{e}^T(t) \mathbf{Q} \mathbf{e}(t) + 2 \|\mathbf{e}^T(t) \mathbf{PM}^* \mathbf{f}^*\| m - 2 \|\mathbf{e}^T(t) \mathbf{P}\lambda\| \|\mathbf{W}\| \\ &= -\mathbf{e}^T(t) \mathbf{Q} \mathbf{e}(t) + 2 \|\mathbf{e}^T(t) \mathbf{P}\lambda\| \{|\boldsymbol{\rho}| m - \|\mathbf{W}\|_{\min}\} < 0 \end{aligned} \quad (17)$$

where \mathbf{W} satisfied with $\|\mathbf{W}\|_{\min} \geq |\boldsymbol{\rho}| m$ must be chosen.

So, we desire to find the condition for the existence of the sliding mode such as

$$\begin{aligned} \dot{\mathbf{e}}_{y_k} \operatorname{sgn}(\mathbf{e}_{y_k}) &= \mathbf{C}_k (\mathbf{A} - \mathbf{L}_k \mathbf{C}_k) \mathbf{e} \operatorname{sgn}(\mathbf{e}_{y_k}) + \mathbf{C}_k (\mathbf{M}^* \mathbf{f}^* - \lambda \mathbf{v}) \operatorname{sgn}(\mathbf{e}_{y_k}) \\ &\leq \mathbf{C}_k (\mathbf{A} - \mathbf{L}_k \mathbf{C}_k) \mathbf{e} \operatorname{sgn}(\mathbf{e}_{y_k}) + |\mathbf{C}_k \mathbf{M}^*| m - \mathbf{C}_k \lambda_k w_k \\ &\leq |\mathbf{C}_k (\mathbf{A} - \mathbf{L}_k \mathbf{C}_k) \mathbf{e}| + |\mathbf{C}_k \mathbf{M}^*| m - \mathbf{C}_k \lambda_k w_k \\ &\leq \|\mathbf{C}_k (\mathbf{A} - \mathbf{L}_k \mathbf{C}_k)\| \|\mathbf{e}\| + |\mathbf{C}_k \mathbf{M}^*| m - \mathbf{C}_k \lambda_k w_k < 0 \end{aligned} \quad (18)$$

where e_{y_k} denotes the k-th output error signal. From the last inequality of Eq. (18), we have

$$\|e\| < \frac{C_k \lambda_k w_k - \|C_k M^*\| m}{\|C_k(A - L_k C_k)\|} \quad (19)$$

Note that this inequality is the sufficient condition for the existence of the sliding mode to be satisfied in the neighborhood of $e_y = 0$. Also, the minimum of the right terms in Eq. (19) shows a disk in which the state errors move on the sliding surface.

3.2 Fault detection and isolation

Assume that the sliding mode observer in Section 3.1 is designed, and that a sliding motion has been achieved, then $e_y = 0, \dot{e}_y = 0$. Define v_{eq} as the equivalent output error injection required maintaining the sliding motion [18]. This can be approximated online to any required accuracy. Under the stability of the output error dynamics and the existence of sliding mode, we get from Eq. (9)

$$0 = CM^*f^* - C\lambda v_{eq} \quad (20)$$

The equivalent feedforward compensation signal v_{eq} can be approximated to continuous signal by replacing Eq. (11) with

$$v_\delta = m \frac{\|CM^*\| e_y}{\|C\lambda\| \|e_y\| + \delta} \quad (21)$$

where δ is a small positive scalar. It follows from Eq. (20) and Eq. (21) that

$$\begin{bmatrix} \Delta_m \\ f_s \end{bmatrix} \approx \begin{bmatrix} \hat{\Delta}_m \\ \hat{f}_s \end{bmatrix} = f^* = (CM^*)^+ (C\lambda)v_\delta \quad (22)$$

From which the reconstruction of each faults matrixes is achieved.

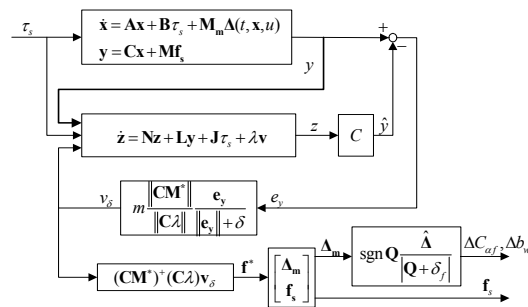

Fig. 4. Scheme of the fault reconstruction proposed.

Since $e_y = 0$ and $e \rightarrow 0$, it follows that $\hat{x} \rightarrow x$, and hence $Q_1(A, B, \hat{x}) \rightarrow Q_1(A, B, x)$, $Q_2(A, B, \hat{x}) \rightarrow Q_2(A, B, x)$ in Eq. (6).

Now, define a reconstruction multiplicative faults signal

$$\Delta \hat{C}_{\alpha_f} = \frac{\hat{\Delta}_{m1}}{Q_1(A, B, \hat{x})}, \Delta \hat{b}_w = \frac{\hat{\Delta}_{m2}}{Q_2(A, B, \hat{x})} \quad (23)$$

It follows that $\Delta \hat{C}_{\alpha_f} \rightarrow \Delta C_{\alpha_f}$, $\Delta \hat{R}_s \rightarrow \Delta R_s$ and hence accurate estimates of the multiplicative faults can be obtained. A more practical way to implement the reconstruction Eq. (23) would be

$$\Delta \hat{C}_{\alpha_f} = \text{sgn} Q_1(A, B, \hat{x}) \frac{\hat{\Delta}_{m1}}{|Q_1(A, B, \hat{x}) + \delta_f|}, \quad \Delta \hat{R}_s = \text{sgn} Q_2(A, B, \hat{x}) \frac{\hat{\Delta}_{m2}}{|Q_2(A, B, \hat{x}) + \delta_f|} \quad (24)$$

where δ_f is a small positive scalar. Provided that $Q > \delta_f$, a good approximation to $\Delta C_{\alpha_f}, \Delta R_s$ can be given by $\Delta \hat{C}_{\alpha_f}, \Delta \hat{R}_s$. A schematic representation of the proposed FDI scheme is shown in Fig. 4. As developed above, the sliding mode observer can be introduced to detect and isolate faults for the SbW system with multiplicative faults and sensor faults.

4. Simulation results

In this section the proposed method is applied to an SbW vehicle system with the parameters in the Table 2.

The system matrices of SbW vehicle system Eq. (6) with faults are given as

$$A = \begin{bmatrix} -2.463 & -0.576 & 1.231 & 0 \\ 1.294 & -1.232 & 5.876 & 0 \\ 0 & 0 & 0 & 1.0000 \\ 0.8175 & 0.068 & -0.817 & -19.73 \end{bmatrix},$$

Table 2. Numerical values of vehicle model parameters.

m	290 kg
I_z	251 kg · m ²
C_{α_f}	2500 N / rad
C_{α_r}	2500 N / rad
a	0.59 m
b	0.72 m

$$B_1 = \begin{bmatrix} 0 \\ 0 \\ 0 \\ 0.719 \end{bmatrix}, \quad B_2 = \begin{bmatrix} 0 \\ 0 \\ 0 \\ -0.0654 \end{bmatrix},$$

$$C = \begin{bmatrix} 1 & 0 & 0 & 0 \\ 0 & 1 & 0 & 0 \\ 0 & 0 & 1 & 0 \\ 0 & 0 & 0 & 1 \end{bmatrix}, \quad M_s = \begin{bmatrix} 0 & 0 \\ 2.35 \times 10^{-4} & 0 \\ 0 & 1 \\ 0 & 0 \end{bmatrix}$$

$$M_m = \begin{bmatrix} 4.92 \times 10^{-5} & 0 \\ 2.35 \times 10^{-4} & 0 \\ 0 & 0 \\ -3.27 \times 10^{-5} & -0.0654 \end{bmatrix},$$

From the Section 3, the feedforward injection map λ is obtained as

$$\lambda = \begin{bmatrix} 2 & 0 & 0 & 0 \\ 0 & 29.8 & 0 & 0 \\ 0 & 0 & 2 & 0 \\ 0 & 0 & 0 & 3.8 \end{bmatrix}$$

In all simulations, the vehicle is assumed to travel at a constant speed of 7 m/s (25.2 Km/h) and the front steering motor torque command with Fig. 5 is used. Then, the normal vehicle states and estimated states using sliding mode observer for the numerical SbW system without faults are shown in Fig. 6. Fig. 7 shows the front tire fault signal which is inserted at 4 second into the nominal system and removed at 10 second. For the cornering stiffness fault in Fig. 7, the results of FDI are shown as Fig. 8, in which the solid line is real faults and the dash-dot line is the reconstruction result for cornering the stiffness fault.

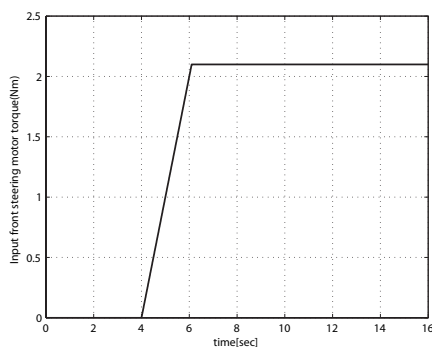

Fig. 5. The command of the front wheel actuator torque.

The simulation results are shown in Figs 9-11 which represent the results of fault reconstruction, i.e., the approximation of yaw rate sensor and front wheel fault, which are random/triangle signal.

Fig. 9 shows simultaneous occurring sensor and multiplicative fault. For sensor and multiplicative fault, the results of FDI are as shown Figs 10-11, in which the solid line is the real fault and the dash-dot line is the reconstructed fault. In the following simulation, the output signals were subject to white

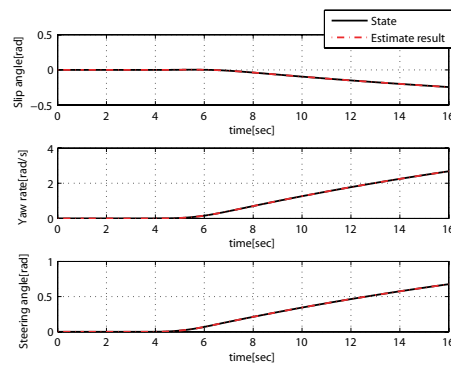

Fig. 6. The responses of estimated states using sliding mode observer without fault signal.

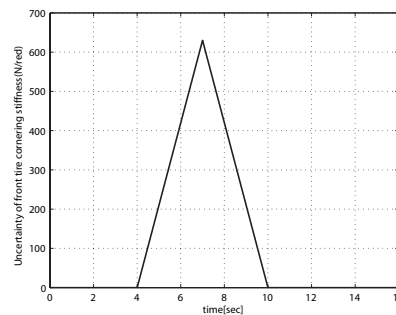

Fig. 7. The uncertainty of the front tire cornering stiffness.

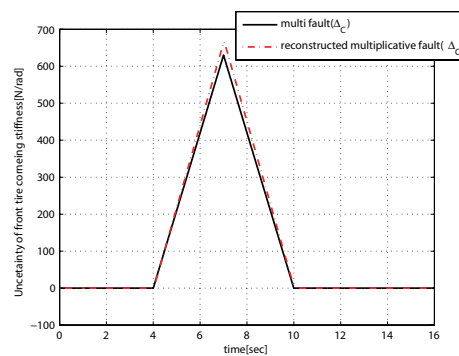

Fig. 8. The reconstruction result of front tire fault.

Gaussian noise. From Eq. (9), it can be seen that theoretically the derivative of the noise appears in the output error and hence constitutes a large disturbance. Thus arbitrarily large values of m would be needed to sustain a sliding motion. From simulation results, it can be seen that the detected and isolated faults almost correspond to real input ones. And we can confirm to simultaneous reconstruct the measurement and multiplicative fault through residual signals. Consequently, the proposed method has achieved its reconstruction as well as the detection and isolation for each fault.

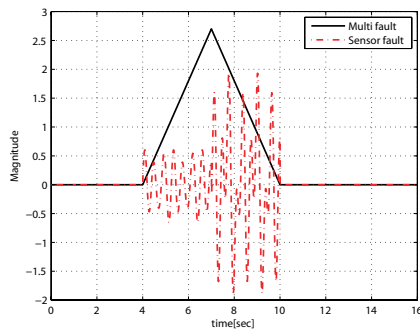

Fig. 9. Sensor and multiplicative fault.

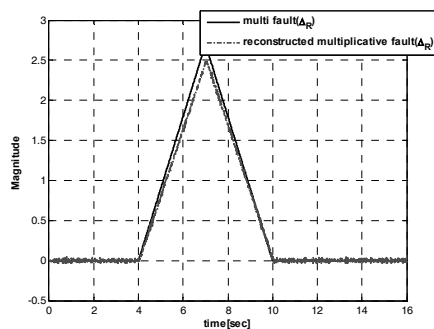

Fig. 10. Reconstruction of sensor fault for triangle signal.

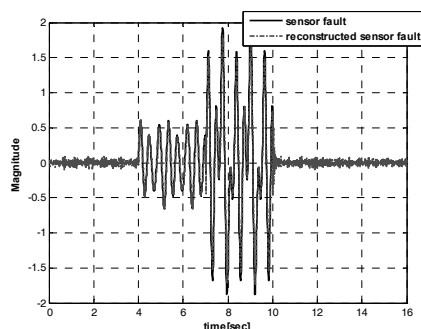

Fig. 11. Reconstruction of multiplicative fault for random signal.

5. Conclusions

This paper has presented the method of fault detection and isolation for an SbW vehicle with sensor and multiplicative faults simultaneously. In SbW vehicle, we first considered the FDI problem for the sensor fault where detecting and isolating are independent of the influence of multiplicative fault. Secondly, a sliding mode observer was designed which adds a general full-order observer for the SbW model to feedforward injection map and feedforward compensation signal, and with sliding mode observer the sensor and multiplicative fault were detected and isolated. Finally, the effectiveness of the proposed method was verified by simulation results.

The inherent perspectives of this work are situated in the general context of an active fault tolerant control for the SbW system. Future works will look forward to:

- Develop fault tolerant control with active reconfiguring schemes for fault accommodation.
- Side slip angle control with active steering of SbW for improving driving performance and stability

References

- [1] M. E. H. Benbouzid, D. Diallo, M. Zeraouia and F. Zidani, Active fault-tolerant control of induction motor drives in ev and hev against sensor failures using a fuzzy decision system. *International Journal of Automotive Technology*, 7(6) (2006) 729-739
- [2] M. Segawa, S. Kimura, T. Kada and S. Nakano, A study on the relationship between vehicle behavior and steering wheel torque on steer by wire vehicle. *Vehicle System Dynamics*, 41 (2004) 202-211.
- [3] M. Shino, P. Raksincharoensak, S. Watanabe and M. Nagai, Vehicle handling and stability control of microscale electric vehicle utilizing steer-by-wire system. *Proceedings of the 7th Int. Symposium on Advanced Vehicle Control*, (2004) 797-802.
- [4] R. J. Patton, P. M. Frank and R. N. Clark, Issues of fault diagnosis for dynamic systems. *Springer*, (2000).
- [5] U. Patton, P. Frank and R. Clark, Fault diagnosis in dynamic systems – theory and applications, *Prentice hall*, (1989).
- [6] C. Edwards, S. K. Spurgeon and R. J. Patton, Sliding mode observers for fault detection and isolation. *Automatica*, 36 (2000) 541-553.

- [7] X. C. Ding, P. M. Frank and E. L. Ding, An approach to the detection of multiplicative faults in uncertain dynamic systems. *Proceedings of the 41st IEEE Conference of Decision and Control*, Las Vegas, NV, (2002) 4371-4376.
- [8] E. Alecorta Garcia and P. M. Frank, Multiplicative fault isolation in linear systems. *Proceedings of the 38th Conference on Decision and Control*, Phoenix, AZ, 3114-3115 (1999).
- [9] T. Hofling and R. Isermann, Parameter estimation triggered by continuous-time parity equations. *Proceedings of the American Control Conference*, Seattle, (1995) 1145-1146.
- [10] S. W. Moon, Y. K. Ji, K. S. Huh, D. G. Cho and J. H. Park, A method of fault diagnosis for steer-by-wire system's sensor using analytical redundancy, *Proceedings of Korean Society of Automotive Engineers Conference*, (2005) 442-447.
- [11] S. P. Ryu, H. S. Jeong, B. H. Kwak and Y. J. Park, Fault diagnosis for vehicles with drive-by-wire systems using Kalman filter, *Proceedings of Korean Society of Automotive Engineers Conference*, (2002) 784-790.
- [12] V. I. Utkin, Sliding modes in control and optimization, Berlin, *Springer*, (1992).
- [13] U. Kiencke and L. Nielsen, Automotive control systems for engine, driveline and vehicle (2nd edition), *Springer*, (2005).
- [14] P. Yih and J. C. Gerdes, Modification of vehicle handling characteristics via steer-by-wire. *IEEE Transactions on Control Systems Technology*, 13(6) (2005) 965-976.
- [15] V. Krishnaswami and G. Rizzoni, Model based health monitoring of vehicle steering system using sliding mode observers. *Proceeding of the American Control Conference*, TA6-9:15, (1996) 1652-1658.
- [16] P. Zhang, S. X. Ding, M. Sader and R. Noack, Fault detection of uncertain systems based on probabilistic robustness theory, *Proceedings of the American Control Conference*, (2005) 1648-1653.
- [17] K. Watanabe and D. M. Himmelblau, Instrument fault detection in systems with uncertainties. *International Journal of Systems Science*, 13 (1982) 137-158.
- [18] T. K. Yeu and S. Kawaji, Sliding Mode Observer based Fault Detection and Isolation in Descriptor Systems, *Proceedings of the American Control conference*, Anchorage, (2002) 4543-4548.



Jae-Sung Im was born in Busan, Korea in 1978. He received his B.S. and M.S degrees in Mechanical Engineering from Pukyong National University, Korea, in 2003 and 2005, respectively. He then received his Ph.D. degree from Kumamoto University, Japan, in 2009. His interests are in vehicle dynamics, robust control, fault detection and isolation, and man-machine interface.



Fuminori Ozaki received the B.S. and M.S. degrees from the Department of Computer Science, Kumamoto University, Japan, in 1998 and 2000. In 2000, he joined OMRON Corporation, Kyoto, Japan, where he developed semiconductor manufacturing equipment. His current interests include EPS control and KANSEI engineering.



Tae-Kyeong Yue received the B.S. and M.S. degrees from Pukyong National University, Korea, in 1998 and 2000, respectively. He received the Ph.D. degree from Kumamoto University, Kumamoto, Japan in 2003. He is working in the Korea Ocean Research and Development Institute (KORDI), Korea. His interests are fault detection and isolation, decentralized control and control of deep-sea mining system.



Shigeyasu Kawaji received his Master of Engineering in Electrical Engineering and Doctor of Engineering in Control Engineering from Kumamoto University and Tokyo Institute of Technology, Japan, in 1969 and 1980, respectively. He joined the Department of Electronic Engineering of Kumamoto University, Japan, where he is presently as a full professor. He is the Director of System Integration Laboratory. He is presently the President of Advanced Health Laboratory Ltd. His current research interest includes robust control, intelligent control mechatronics and robotics, fusion of medicine and engineering, and automotive mechatronic systems.